

RRANGEMASTER
SYSTEMS

Rangemaster Rxu Receiver User manual



Order code: RX-u
Revision Date: 22.12.2021

TABLE OF CONTENTS

1. DESCRIPTION OF UNIT.....	2
1.1 FEATURES.....	2
1.2 DISCIPLINES.....	2
1.3 TECHNICAL DATA.....	2
1.4 OPTIONAL ACCESSORIES OR DEVICES.....	3
2. INSTALLATION RECOMMENDATIONS.....	4
3. CONNECTING.....	5
4. LEGEND.....	7
5. SETTINGS.....	8
5.1 ADDRESS TABLE TO SET UP TRAP WITH LETTERS FROM A TO X.....	9
5.2 ADDRESS TABLE TO SET UP LAYOUT WITH NUMBERS FROM 1.1 TO 8.4.....	10
5.3 ADDRESS TABLE TO SET UP LAYOUT WITH NUMBERS FROM 1 TO 31.....	11
6. TROUBLESHOOTING.....	12
7. LIMITED WARRANTY.....	13
8. RMA FORM.....	14

Copyright Maxima WarenhandelsGmbH © Rangemaster Systems - all material published on this manual is protected by copyright including design of circuits and software.

You are expressly prohibited from electronically storing any material found here or republishing it by any means. Furthermore it is prohibited to reverse-engineer software or hardware, disassemble or copy software or hardware or parts of it.

This unit has been carefully produced for / by:

Maxima WarenhandelsGmbH
© Rangemaster Systems
Dr. Robert Graf Straße 64/9
Graz, A-8010
Austria/Europe

Phone: +43 699 104 03 204
Fax: +43 720 920 195
Mail: info@rangemaster.at
Web: www.rangemaster.at

1. DESCRIPTION OF UNIT

Rangemaster RX-u receiver is a device for receiving radio commands, controlling traps for releasing clay targets for sporting & compak sporting

1.1 FEATURES

- 1 out of 24 channel receiver
- External high gain antenna
- Up to 500m range with Rangemaster transmitters (LoS)
- Operational temperature: -30°C to +70°C
- Power (input): via trap or car battery, optional external power supply
- Polarity fail-safe
- Transmission-addresses settable: 32
- Possibility to run up to 32 ranges without any interference
- Heavy duty relay built in (dry contact)

1.2 DISCIPLINES

Sporting and Compak Sporting

1.3 TECHNICAL DATA

Power Input:	Power (input): via trap/car battery, external power supply, polarity fail-safe
Power consumption:	<50mA
Min. supply voltage:	9 VDC
Max. supply voltage:	24VDC
Operation temperature:	-30°C to +70°C
Dimensions:	Height: 8cm , 5.5: cm, depth: 4.5 cm
Weight:	Around 100 gr
Output:	Dry contact
Frequency:	433 MHz
Type of modulation:	FSK
Baud rate:	2 kBd
Max. permitted voltage:	24 V
Max. permitted current:	1,0 A

Television reception:	No
Data encryption:	No
Internet access:	No

1.4 OPTIONAL ACCESSORIES OR DEVICES

Remote controls/Transmitters

8 Channel digital remote control "IQ-SERIES"	TXIQ8
16 Channel remote control "IQ-SERIES"	TXIQ16
24 Channel remote control "IQ-SERIES"	TXIQ24
16 Channel Sporting Commander with chip card payment incl. Chip card reader and LCD	TXSPO16
Multifunctional Smart Transmitter	TXSMART

Extras for remote range control

Rangemaster X3 pro net complete professional range automation system	X3PRO
Rangemaster X2 sequencer + Buran	X2

2. INSTALLATION RECOMMENDATIONS

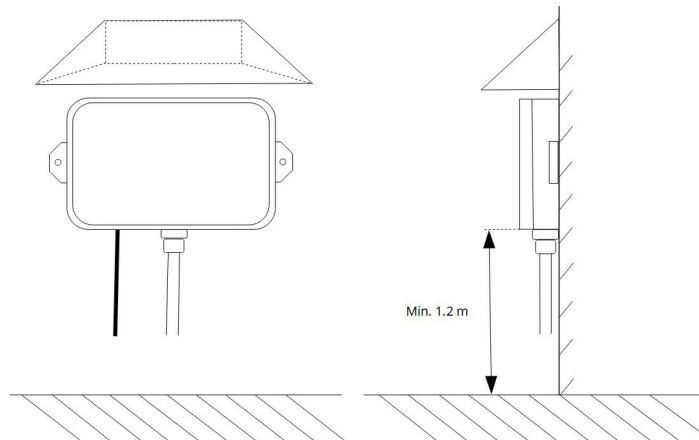

IMPORTANT:

Optimum height of the receiver is **1.5m above the ground**, but not below 1.2 m.

Antenna should hang down.

Never leave the receiver on a battery, on the ground or on a trap!

It is recommended to install the receiver **under cover** if possible (e.g. inside a trap cover or under a canopy) to extend the life of the device.

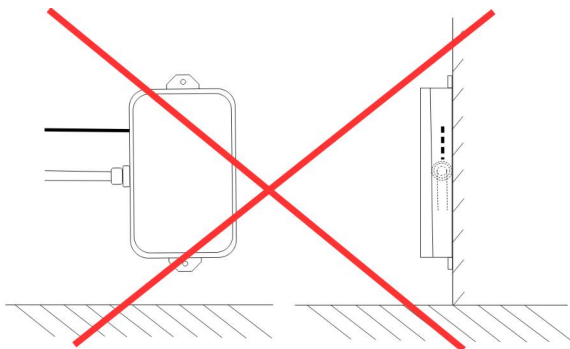
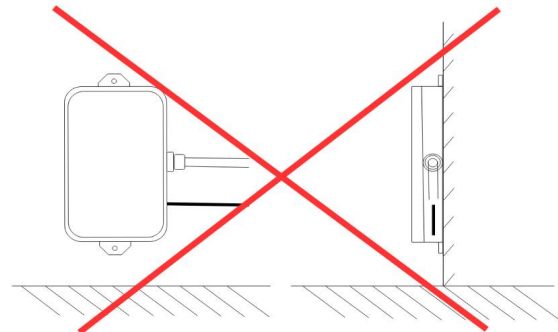
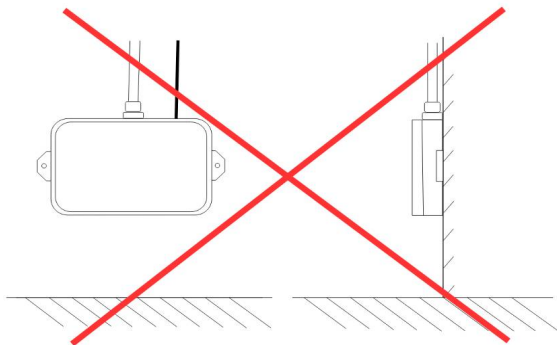

3. CONNECTING

The receiver is connected to the trap using a connector and a cable (the connector and cable are not included in the basic configuration).

In accordance to the trap used, customer can order or purchase connectors and a 4-core cable with a diameter of 0.75 mm² for connecting smart receivers with traps.

Connection scheme of wires on the socket of **Rangemaster RX-u receiver** for connecting to traps when customer uses 4 coloured wire (blue, black, brown and yellow/green):

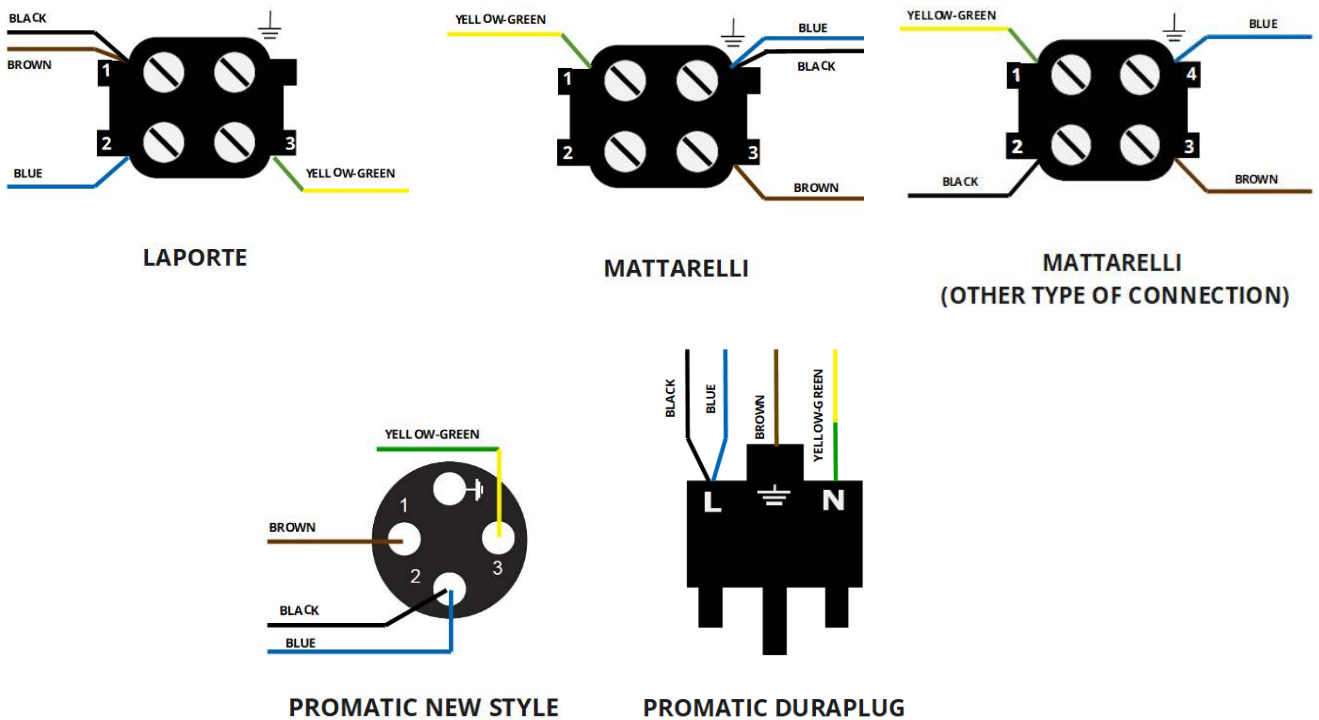

Rangemaster Rx-u wires connecting scheme:

Wire colour	Definition
brown	Power/ plus
blue	Minus
black	Dry contact (relay)
yellow/green	Dry contact (relay)

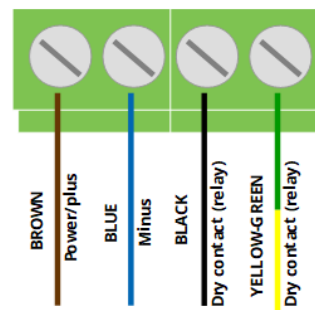

NOTE: Optimum height of the receiver is **1.5m above the ground**, but not below 1.2 m. Antenna should hang down.

IMPORTANT: The relay is used for switching signals only (dry contact) and must not switch heavy loads (e.g. a solenoid)!

If machines are used where it is necessary to switch the solenoid, then an intermediate relay must be used!

Max. current – 0.5A

If cables are supplied by Rangemaster Systems:

customer gets cables with numbers written on each wire: #1, #2, #3, #4:

Wire number	Definition
1	Power/ plus
2	Minus
3	Dry contact (relay)
4	Dry contact (relay)

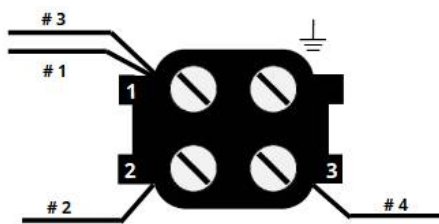
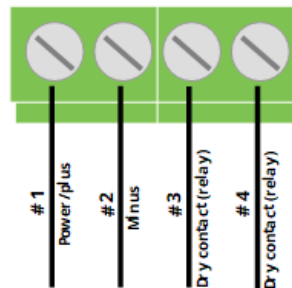

LAPORTE

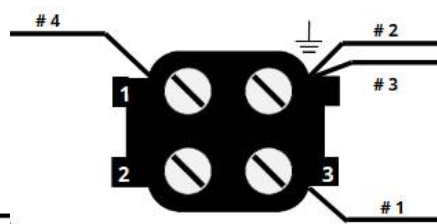

MATTARELLI

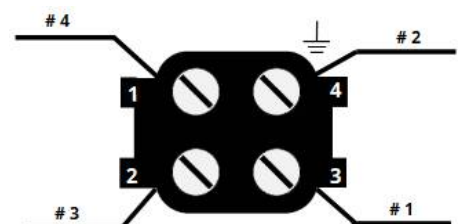

**MATTARELLI
(OTHER TYPE OF CONNECTION)**

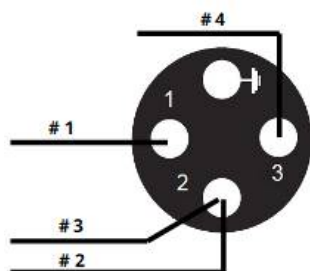

PROMATIC NEW STYLE



PROMATIC DURAPLUG

NOTE: Mattarelli traps can have different way of cabling and sometimes supplies 220V through the 4 pins plug. That's why before connecting, verify that the pinout and voltage applied by Mattarelli is correct and that the Mattarelli feeding box supplied 24V DC MAX.

4. LEGEND

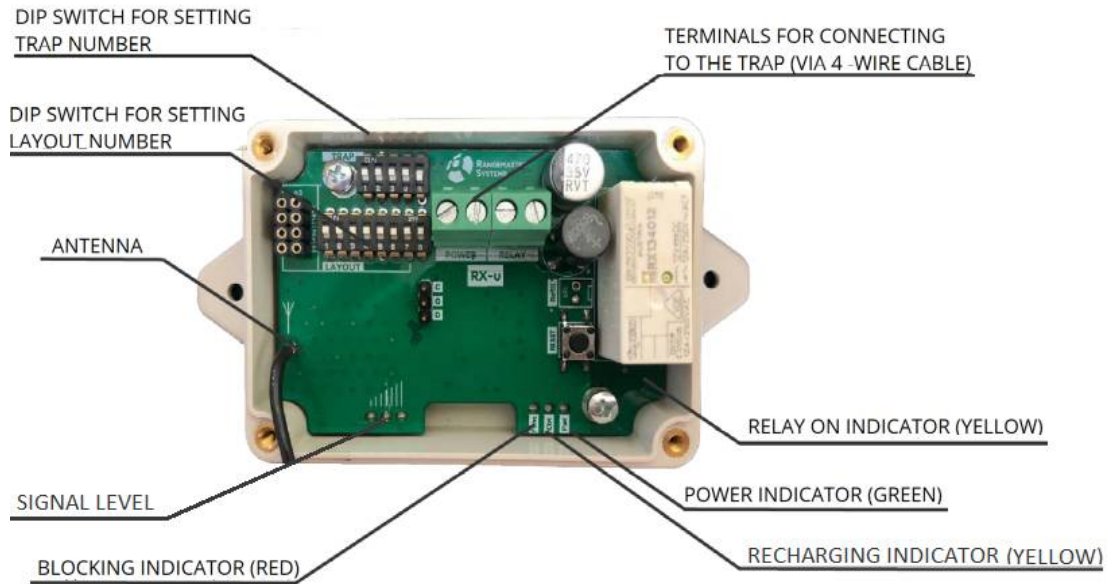



LED INDICATORS:

Indicator	Indicator color	Description
Signal level	green	Shows 3 signal levels: strong, medium and weak.
Blocking indicator	red	1. Switches on if the address on the trap is set incorrectly (0 or higher than 24) 2. When changing the trap address (blinking once)
Relay on indicator	yellow	Switches on when the relay is on (see switch No. 8 on the Layout DIP-switch in section 5)
Power indicator	green	Switches on when the power is on
Recharging indicator	yellow	Switches on for the time specified by switch No. 7 and Nr. 8 (see Layout DIP-switch in section 5). While the indicator is on, the receiver does not respond to commands.

5. SETTINGS

 To set the **RX-u Receiver** to the certain layout and trap use:

TRAP DIP-switch	LAYOUT DIP-switch
	
5 switches	8 switches
Sets address for traps on the layout. Each trap should have unique address on one layout. E.g.: Trap A, Trap B, etc. To set up the address use table in section 5.1 .	Switches from 1 to 5: Sets the address of the layout. Must be the same for all receivers on the same layout. E.g.: Layout 1 / A To set up the address use table in section 5.2 or 5.3 .
	Adjusting the recocking time of the trap (it does not accept any commands at this time): Switch No. 7: ON / UP position - 2.4 sec; OFF / DOWN - 1.2 sec
	Relay response time adjustment. Switch No. 8: ON / UP position - 0.8 sec; OFF / DOWN - 0.4 sec.
NOTE: NEVER USE 0 CHANNEL FOR TRAP! NEVER USE ADDRESS HIGHER THAN 24!	NOTE: ENSURE ALL LAYOUTS HAVE DIFFERENT CHANNELS! NEVER USE ADDRESS HIGHER THAN 31!

5.1 ADDRESS TABLE TO SET UP TRAP WITH LETTERS FROM A TO X

DIP-Schalter/ Channel	1	2	3	4	5
01 - A	ON	OFF	OFF	OFF	OFF
02 - B	OFF	ON	OFF	OFF	OFF
03 - C	ON	ON	OFF	OFF	OFF
04 - D	OFF	OFF	ON	OFF	OFF
05 - E	ON	OFF	ON	OFF	OFF
06 - F	OFF	ON	ON	OFF	OFF
07 - G	ON	ON	ON	OFF	OFF
08 - H	OFF	OFF	OFF	ON	OFF
09 - I	ON	OFF	OFF	ON	OFF
10 - J	OFF	ON	OFF	ON	OFF
11 - K	ON	ON	OFF	ON	OFF
12 - L	OFF	OFF	ON	ON	OFF
13 - M	ON	OFF	ON	ON	OFF
14 - N	OFF	ON	ON	ON	OFF
15 - O	ON	ON	ON	ON	OFF
16 - P	OFF	OFF	OFF	OFF	ON
17 - Q	ON	OFF	OFF	OFF	ON
18 - R	OFF	ON	OFF	OFF	ON
19 - S	ON	ON	OFF	OFF	ON
20 - T	OFF	OFF	ON	OFF	ON
21 - U	ON	OFF	ON	OFF	ON
22 - V	OFF	ON	ON	OFF	ON
23 - W	ON	ON	ON	OFF	ON
24 - X	OFF	OFF	OFF	ON	ON

5.2 ADDRESS TABLE TO SET UP LAYOUT WITH NUMBERS FROM 1.1 TO 8.4

DIP switch/Channel	1	2	3	4	5	X	X	X
1.1	OFF	OFF	OFF	OFF	OFF	OFF	OFF	OFF
1.2	ON	OFF	OFF	OFF	OFF	OFF	OFF	OFF
1.3	OFF	ON	OFF	OFF	OFF	OFF	OFF	OFF
1.4	ON	ON	OFF	OFF	OFF	OFF	OFF	OFF
2.1	OFF	OFF	ON	OFF	OFF	OFF	OFF	OFF
2.2	ON	OFF	ON	OFF	OFF	OFF	OFF	OFF
2.3	OFF	ON	ON	OFF	OFF	OFF	OFF	OFF
2.4	ON	ON	ON	OFF	OFF	OFF	OFF	OFF
3.1	OFF	OFF	OFF	ON	OFF	OFF	OFF	OFF
3.2	ON	OFF	OFF	ON	OFF	OFF	OFF	OFF
3.3	OFF	ON	OFF	ON	OFF	OFF	OFF	OFF
3.4	ON	ON	OFF	ON	OFF	OFF	OFF	OFF
4.1	OFF	OFF	ON	ON	OFF	OFF	OFF	OFF
4.2	ON	OFF	ON	ON	OFF	OFF	OFF	OFF
4.3	OFF	ON	ON	ON	OFF	OFF	OFF	OFF
4.4	ON	ON	ON	ON	OFF	OFF	OFF	OFF
5.1	OFF	OFF	OFF	OFF	ON	OFF	OFF	OFF
5.2	ON	OFF	OFF	OFF	ON	OFF	OFF	OFF
5.3	OFF	ON	OFF	OFF	ON	OFF	OFF	OFF
5.4	ON	ON	OFF	OFF	ON	OFF	OFF	OFF
6.1	OFF	OFF	ON	OFF	ON	OFF	OFF	OFF
6.2	ON	OFF	ON	OFF	ON	OFF	OFF	OFF
6.3	OFF	ON	ON	OFF	ON	OFF	OFF	OFF
6.4	ON	ON	ON	OFF	ON	OFF	OFF	OFF
7.1	OFF	OFF	OFF	ON	ON	OFF	OFF	OFF
7.2	ON	OFF	OFF	ON	ON	OFF	OFF	OFF
7.3	OFF	ON	OFF	ON	ON	OFF	OFF	OFF
7.4	ON	ON	OFF	ON	ON	OFF	OFF	OFF
8.1	OFF	OFF	ON	ON	ON	OFF	OFF	OFF
8.2	ON	OFF	ON	ON	ON	OFF	OFF	OFF
8.3	OFF	ON	ON	ON	ON	OFF	OFF	OFF
8.4	ON	ON	ON	ON	ON	OFF	OFF	OFF

5.3 ADDRESS TABLE TO SET UP LAYOUT WITH NUMBERS FROM 1 TO 31

DIP switch/Channel	1	2	3	4	5	X	X	X
00	OFF	OFF	OFF	OFF	OFF	OFF	OFF	OFF
01	ON	OFF	OFF	OFF	OFF	OFF	OFF	OFF
02	OFF	ON	OFF	OFF	OFF	OFF	OFF	OFF
03	ON	ON	OFF	OFF	OFF	OFF	OFF	OFF
04	OFF	OFF	ON	OFF	OFF	OFF	OFF	OFF
05	ON	OFF	ON	OFF	OFF	OFF	OFF	OFF
06	OFF	ON	ON	OFF	OFF	OFF	OFF	OFF
07	ON	ON	ON	OFF	OFF	OFF	OFF	OFF
08	OFF	OFF	OFF	ON	OFF	OFF	OFF	OFF
09	ON	OFF	OFF	ON	OFF	OFF	OFF	OFF
10	OFF	ON	OFF	ON	OFF	OFF	OFF	OFF
11	ON	ON	OFF	ON	OFF	OFF	OFF	OFF
12	OFF	OFF	ON	ON	OFF	OFF	OFF	OFF
13	ON	OFF	ON	ON	OFF	OFF	OFF	OFF
14	OFF	ON	ON	ON	OFF	OFF	OFF	OFF
15	ON	ON	ON	ON	OFF	OFF	OFF	OFF
16	OFF	OFF	OFF	OFF	ON	OFF	OFF	OFF
17	ON	OFF	OFF	OFF	ON	OFF	OFF	OFF
18	OFF	ON	OFF	OFF	ON	OFF	OFF	OFF
19	ON	ON	OFF	OFF	ON	OFF	OFF	OFF
20	OFF	OFF	ON	OFF	ON	OFF	OFF	OFF
21	ON	OFF	ON	OFF	ON	OFF	OFF	OFF
22	OFF	ON	ON	OFF	ON	OFF	OFF	OFF
23	ON	ON	ON	OFF	ON	OFF	OFF	OFF
24	OFF	OFF	OFF	ON	ON	OFF	OFF	OFF
25	ON	OFF	OFF	ON	ON	OFF	OFF	OFF
26	OFF	ON	OFF	ON	ON	OFF	OFF	OFF
27	ON	ON	OFF	ON	ON	OFF	OFF	OFF
28	OFF	OFF	ON	ON	ON	OFF	OFF	OFF
29	ON	OFF	ON	ON	ON	OFF	OFF	OFF
30	OFF	ON	ON	ON	ON	OFF	OFF	OFF
31	ON	ON	ON	ON	ON	OFF	OFF	OFF

6. TROUBLESHOOTING

№	Problem	Possible reason	Solution
1.	Trap does not respond	Wrong layout or trap address	Set layout or trap address — refer to section 5
2.	Trap does not respond and the power indicator is off	Bad contact in the connector or cable damage	Check the cable for damage and open the connector, check the connection of the wires inside the connector — refer to section 3 2. Check the voltage between the blue and brown wires with a multimeter to make sure that the trap supplies power.
3.	Trap does not respond when releasing the same targets in a row	Trap is recocking. Depending on the recharge time of the trap, the receiver is blocked and stops receiving a signal (see Layout DIP-switch - section 5)	Make 2-3 seconds gap between the release of the same target
4.	Trap does not respond	Due to the low temperature, the trap may not have time to recharge due to an increase in the response time of the relay	Increase the relay response time by moving switch No. 8 to the ON / up position — refer to section 5
5.	Trap does not respond	The problem with the remote control: - battery is low - antenna is damaged	1. Check the battery level with the multimeter and, if necessary, replace with new ones. 2. Repair the antenna or replace
6.	Poor signal level	1. The problem with the remote control. 2. The receiver is installed at a distance farther than the signal coverage area of the remote control 3. The receiver antenna is damaged.	1. See line 5 above. 2. The optimum height of the receiver is 1.5m above the ground, but not lower than 1.2m. 3. Repair the antenna or replace

7. LIMITED WARRANTY

Rangemaster Systems gives a limited warranty on this products against defects in material or workmanship for time of 12 months.

This period starts upon receipt of the product.

Rangemaster Systems will not be liable for loss of data or loss of profit or turnover due to a defect.

The warranty only includes repair or replacement of defect components, which failed during daily use. "Daily use" has to be read as: Use in accordance to specifications and in intended use.

General information & warranty exclusions: Damages due to water, moisture, vandalism, lightening, surges over power line or power supply, usage outside of specifications, dropping the product, excessive heat or cold (both for operation and storage) damages because of dropping the product, unnecessary force, damages because of empty or discharged batteries or accumulators are warranty exclusions and do not entitle you for a free of charge repair or replacement.

In case of chip card readers with contacts are built in the product. Items or dirt inside the reader are warranty exclusions.

In case of touch screens are built in the product: Damages due to improper use (using something else than your finger) causing scratches or punctures on the screen or on the touch surface will not be covered with warranty.

Please ask for a RMA number by sending an email to support@rangemaster.at
Add invoice number, date of invoice and serial number of product.
Also add a detailed description of errors.

Return unit for repair to:

Maxima WarenhandelsGmbH
© Rangemaster Systems – Ext. Storage
8082 Weissenbach 9
Austria/Europe

Show your RMA number of the box. Send us a tracking link after returning the product to us.

8. RMA FORM

To:
 Maxima WarenhandelsGmbH
 © Rangemaster Systems – Ext. Storage
 8082 Weissenbach 9
 Austria/Europe

RMA: _____

Date: ____/____/____

Date of purchase	
Supplied by	
Invoice number (Please attach copy of invoice)	
Product serial number	
Description of error	

Please return to:

Name	
Club	
Address 1	
Address 2	
Zip code	
City/Town	
Country	
Phone	
E-Mail	